

MANGER

PRECISION IN SOUND

Table of Contents

About Manger	4
Manufactory	8
Products	10
Options	36
Colors and Finishes	38
Contact	40



IT'S ABOUT TIME.

Music is much more than a collection of notes, tones and beats. You realise this if you ever had goose bumps listening to music. Music can trigger emotions and touch the heart. It is our mission to let you experience these emotions.

To achieve this goal we turned the technology of traditional loudspeakers upside down and developed a system that reproduces music in a transparent, authentic, and pure fashion: the Manger Sound Transducer®.

This brochure will tell you more about our unique technology and its relationship to nature itself.

For more than 40 years Manger Audio has been delivering ever increasing innovation in the pursuit for perfect audio reproduction that has been admired and awarded prizes by the trade press and editors worldwide. It took masters in technology, workmanship, and design to achieve the incomparably pristine music reproduction of Manger Audio. I hope you will enjoy reading this brochure and look forward to welcoming you into our community of connoisseurs and customers.

A handwritten signature in blue ink, appearing to read 'Daniela Manger', with a long horizontal flourish extending to the right.

Daniela Manger
CEO Manger Audio



»In my view a sound transducer should be capable of reproducing all types of acoustic sensations equally well, irrespective of whether this is a concert or a discussion. It is just as important to be able to reproduce natural sounds such as a birdsong and the wind in the trees where the only human contribution is the sound of a distant church bell. The loudspeaker itself should not be perceptible in this listening experience. No natural resonance or changes in the sound field should betray its presence.«

Josef Manger

Acoustic researcher and inventor of the Manger Sound Transducer

ACOUSTICAL REALITY

The ear is the widest-ranging perceptory organ that nature has given us. The eye reacts to wavelengths between 400 and 700 nanometers, within the spectrum of visible light. Anything below this (x-rays or gamma rays for example) cannot be registered by the naked eye. And the same is true for higher wavelengths. Expressed in frequencies this means that the eye can register a range of around one octave; the ear, on the other hand, can register ten octaves. So, if our eyes were as good as our ears then we would be able to look through everything with x-ray vision, and could turn night into day with infrared sight.

This phenomenal performance by our hearing system, with its tiny hair cells that react to fluctuations in the air pressure with movements of around 100 billionth of a millimeter, make our ears the most uncompromising instrument that register everything without fail and they ruthlessly uncover every single change. And this has wide-ranging consequences. Even before we perceive tones, our ears register noises that last no longer than 0.01 milliseconds (1000-times faster than the first perception of sound occurs).



INSPIRED BY NATURE



For human ears the sound reproduction of traditional loudspeakers is far from being convincingly realistic. In addition to incorrect spatial imaging, standard loudspeakers constantly remind the listener of their position and presence due to transient flaws and noise. These are crucial factors that mask the delicate nuances of the reproduced music to diminish the listening experience.

When you listen to a Manger Sound Transducer for the first time, you will immediately notice its realistic spatial representation and authenticity. The secret lies in its bending wave design that nature itself used to develop the basilar membrane of our hearing organ.



SOURCE OF NATURAL SOUND

Josef Manger spent years systematically researching, testing and rejecting until the vision of the natural resonance-free radiation principle became an acoustic reality.

This has resulted not only in one of the most elegant concepts on the loudspeaker market, but also in a masterpiece of precision mechanics. The decisive factor in the Manger Sound Transducer was the logical rejection of the hundred year-old transducer principle used in conventional loudspeakers, thereby eliminating away with the piston-like movements with their faulty overshoots. Instead, Josef Manger relied on the principle of bending waves, which starting from the center

of a plate-like diaphragm, travel to the outside like waves after a stone is thrown into water. This led to the first fundamental patent in 1974. High frequencies quickly attenuate in the inner area of the membrane, whereas long waves (low frequencies) reach right to the edge of the star-shaped damper. There they are absorbed so that no reflections can come from the outer perimeter.

That the Manger Sound Transducer, in spite of its large frequency range of between 80 Hz and 40 kHz and its sensitivity of 91 dB 1W/1m, can achieve the tremendously fast rise time of 13 μ s is attributable to many design finesses.

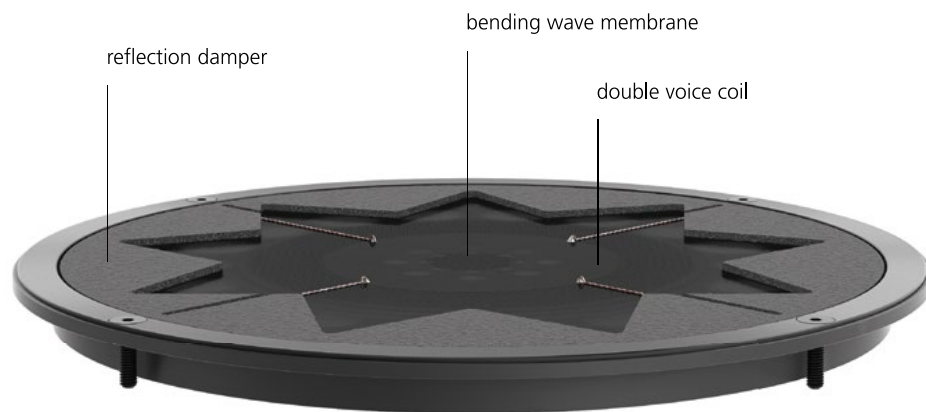

Side view of the Manger Sound Transducer®

FORM FOLLOWS FUNCTION

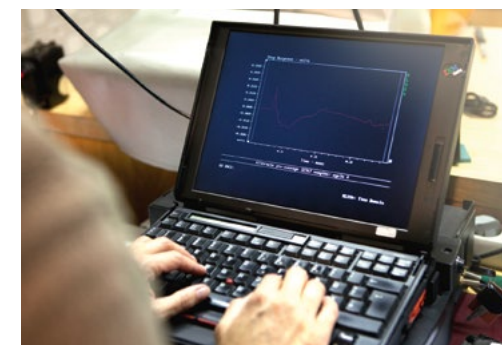
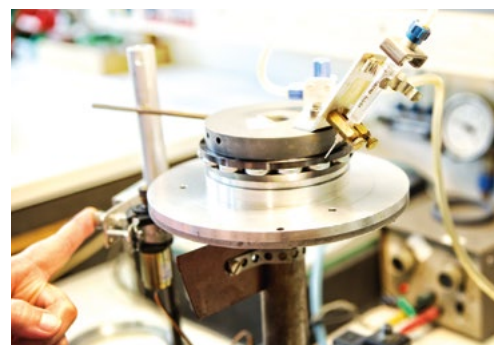

The double voice-coil - the solution is both simple and clever, but nevertheless producible only under the most difficult conditions.

Two voice coils, mounted mechanically in series and switched electrically in parallel, using aluminum wire on an aluminum backing and copper strip leads, produce the solution of an overall long, but nevertheless extremely light driving coil. This is unique for a wide-band transducer; maximum displacement of ± 3.5 mm and a total weight of only 0.4 grams.

No less than 15 neodymium magnets concentrating their extremely strong magnetic field of 1.32 Tesla on an air gap of only 0.95 mm width, in which the lightweight 70 mm diameter coil moves, supply the drive for the diaphragm.

The membrane – the centerpiece – is not stiff like in conventional reciprocating loudspeakers, but flexible. So it does not store any energy that would produce disturbing transient noise.



EVERY DRIVER IS A UNIQUE PRODUCT



Custom manufacturing has another advantage: the cage of every single Manger Sound Transducer is numbered after all checks have been successfully carried out. This means that every customer is registered in the manufacturing documentation and benefits not only from the three-year guarantee, but also enjoys the fair service warranty of the manufacturer, offered as a personal customer service.



Josef Manger has been active in sound transducer research and development for over forty years and began manufacturing the Manger Sound Transducer in 1985. He holds 40 patents worldwide and was awarded the Diesel medal in 1982, one of Germany's highest awards for engineering excellence.



MADE IN GERMANY

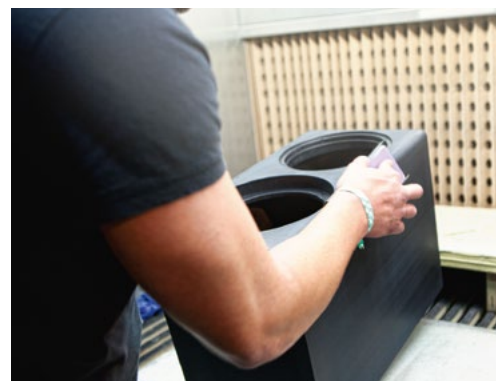

The demands on the construction of a Manger Sound Transducer are so complex that its quality standards cannot be met solely by a single measure. Based on our credo "quality is indivisible" the Manger Sound Transducer is manufactured with extreme attention to craftsmanship and rarely seen use of premium-quality materials.

● ● ● **Made in Germany**



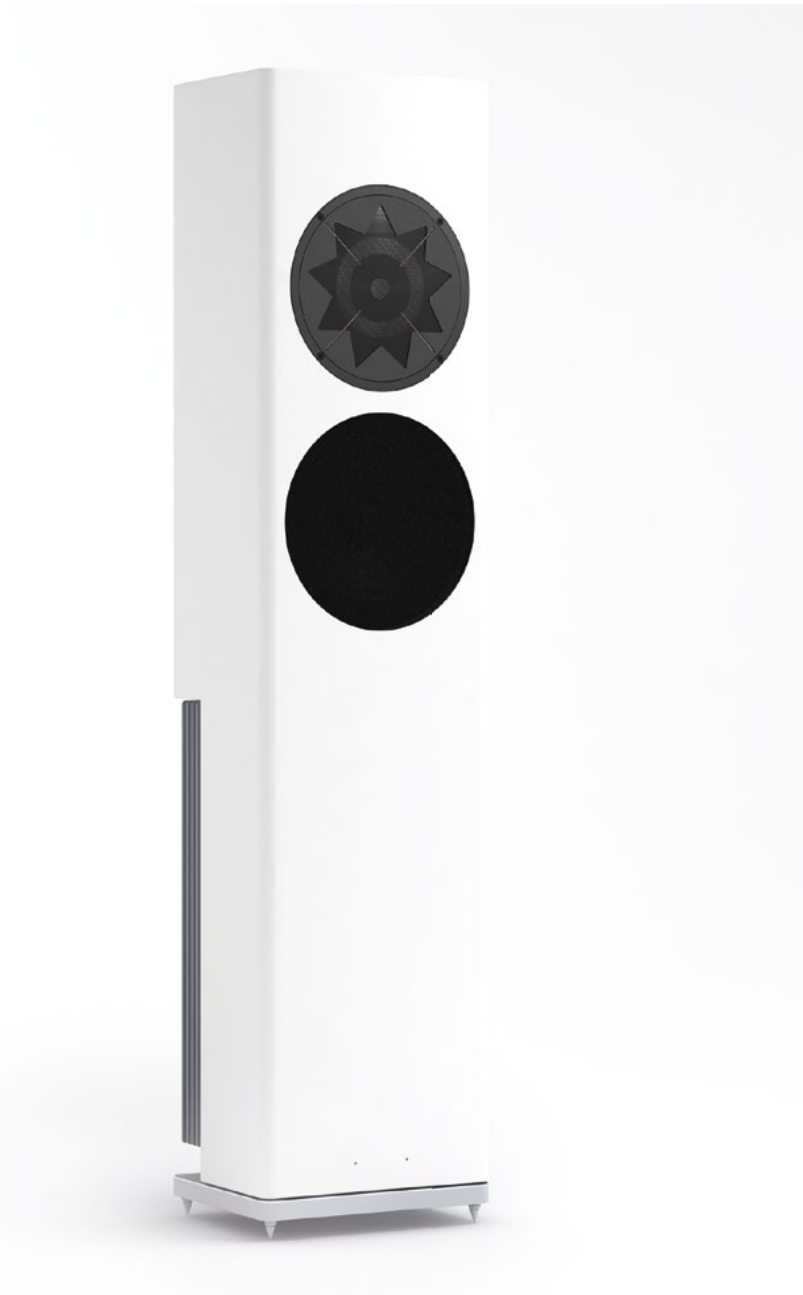

ULTIMATE CHOREOGRAPHY

s1

Music is much more than a collection of notes, tones and beats. It merges creativity, art and passion in a temporal context. Perfect timing is the core of music – this applies to the original and the reproduction. The s1 active loudspeakers follow this choreography more consistently than any other transducer and are able to reproduce music in a uniquely transparent and holistic fashion.



DESIGN AND TECHNOLOGY IN HARMONY

The tasteful appearance of the s1 cunningly hides all the efforts and rigors that went into the smallest detail of each component. Ultra-solid bracings prevent detrimental resonances of the baffles and standing waves within the cabinet. The two chassis have been meticulously inserted into a 1,5"

front panel and are housed in separate sealed compartments. Lavishly rounded cabinet edges reduce sound diffractions, optimize radiation and emphasize the timeless elegance of these exceptional loudspeakers.





ELABORATED IN EVERY DETAIL

No element of the s1 has been left to chance. As Manger puts it: Even the smallest component is of critical importance as part of a chain that is only as strong as its weakest link. Not only the chassis are attached to the cabinet with durable threaded screws, but the amplifier and control electronics as well. The electronics

housing consists of diligently crafted, almost resonance-free aluminum and butts up seamlessly to the loudspeaker enclosure. The cables are fed in through a generous recess at the bottom to avoid bending. The solid socket construction of the s1 models stands on adjustable steel spikes and makes perfect contact with the floor.

General

Type	Active 2-Way Floorstanding System
Frequency Range	30 Hz – 40 kHz
Crossover frequency	330 Hz
Maximum SPL	110 dB
Dimensions (H x B x T)	44.8 x 10.6 x 8.4" (1139 x 270 x 214 mm)
Weight	105.7 lbs (48 kg)

Amplifiers

Max. Power Output LF	250 W @ 8 Ohm Class AB
Max. Power Output HF	180 W @ 8 Ohm Class AB
Power Bandwidth HF	250 kHz (-3 dB)
Input Sensitivity	6 dBu (1.55 V) or 0 dBu
Input Impedance	10 kOhm
Input	XLR-3 (balanced)





MAGIC MOMENTS

p1

Challenge a conventional loudspeaker to distinguish the vivid and fresh performance of a Stradivari from the smooth full tone of a violin made by Guarneri and it will fail. The Manger p1, however, offer music lovers this subtle distinction. With their breathtakingly natural sound quality and their authentic reproduction the p1 reward you with magic moments.



INTELLIGENT ENTITY

The rounded edges of the p1 cabinet improve sound radiation and contribute to the distinct yet unobtrusive appearance of the loudspeakers. Inside the cabinet, bracings ensure optimum working conditions and nip resonances in the

bud. Both Manger Sound Transducer and high performance woofer are housed in a sealed compartment of their own. Thanks to this intelligent construction detrimental sonic interactions via enclosed air are completely avoided.





CRÈME DE LA CRÈME

Quality down to the finest detail – the credo is a common thread in the p1 and all Manger loudspeakers. Highest fidelity is ensured by premium crossover components. Large-diameter cables handle lossless signal transfer. Binding posts, made by WBT nextgen™, are of premium quality

and readily accessible. Banana plugs or spade terminals of the speaker cables never lose contact. Last but not least the chassis and terminal strips are precisely anchored into the cabinet with durable treaded screws. Uncompromising quality that you can see, feel and hear.

General

Type	Passive 2-Way Floorstanding Speaker
Impedance	4 Ohms
Frequency range	40 Hz – 40 kHz
Crossover frequency	360 Hz
Sensitivity	89 dB 1 W/1 m
Maximum SPL	106 dB
Dimensions (H × B × T)	44.8 × 10.6 × 8.4 (1139 × 270 × 214 mm)
Weight	61.7 lbs (28 kg)





THE NEXT STEP

p2

To come as close as possible to the original has always been the ambition of Manger Audio. Along this path Josef W. Manger has accomplished a technological masterpiece: the Manger Sound Transducer. The flagship model p2 consistently acts on this maxim and takes another important step in approaching the ideal of time correct and faithful audio reproduction. The p2 open up a new horizon.



SPEED IS THE KEY

A precondition on the path to authentic reproduction is time correct and integral rendition. Due to its design the Manger Sound Transducer provides an impulse fidelity, in other words the ability to rapidly track short signals, that is far superior to conventional drivers. The newly

developed woofer system of the p2 also achieves an extraordinarily high signal fidelity and perfectly complements the Manger Sound Transducer. The two innovations merge into a uniquely authentic reproduction system.

DEEPLY IMPRESSIVE

The p2 woofer is groundbreaking. The patented drivers, developed and manufactured in Germany, features a modern sandwich-type membrane. Two carbon fiber reinforced cellulose layers flank a layer of high-tech foam. The sophisticated material mix combines high inner damping with little weight and extreme

rigidity. Partial vibrations and fractured radiation to higher frequencies are thus effectively eliminated. The powerful driving coil ensures linear excursion and minimum harmonic distortion. In combination with two meticulously tuned passive membranes the woofer provides matchlessly precise reproduction down to the lowest register.



ROCK IN THE SURF

In operation, considerable force is sometimes applied to the loudspeaker housing. If it is stimulated to vibrate, this leads to audible color discoloration. The housing of the p2 is a manifestation of solidity. Inner struts and stiffeners at defined points effectively prevent natural vibrations. The

chassis reside in a 38-millimeter (!) strong front and the elegantly rounded edges optimize the radiation behavior. A solid base construction made of aluminum guarantees rock-solid stand on any surface.

BOUNDLESS DIVERSITY

A speaker literally becomes part of a living space. That's why Manger Audio, as a manufacturer, offers you an almost unlimited choice of finishes.

Whether color (all RAL and NCS colors) or fine veneer, whether glossy or matt - let your imagination and your desires run wild.

General

Type	Passive 2-Way Floorstanding Speaker
Impedance	8 Ohms
Frequency range	30 Hz – 40 kHz
Crossover frequency	340 Hz
Sensitivity	89 dB 1 W/1 m
Maximum SPL	112 dB
Dimensions (H × B × T)	44.8 × 10.6 × 8.4 (1139 × 270 × 214 mm)
Weight	70.6 lbs (32 kg)





THE ACOUSTIC LENS

c1

Music has no limits. The soft tones of a Gregorian chant, the powerful dynamics of a symphony, the cutting guitar riffs of a metal band – the c1 active compact monitors handle everything expertly. These loudspeakers serve the music so neutrally that renowned recording studios consider the c1 as indispensable.



WINNING TEAM

In high-performance sport the efficiency of a well coordinated team paves the way to the winner's podium. In the audio world the flawless interaction of all elements makes the c1 world champions of sound. The c1 boast premium components which have been determined during

intensive listening tests. The robust enclosure provides optimum conditions for the chassis and sophisticated electronics. Cabinet resonances leading to sonic colorations are effectively eliminated.





UNCOMPROMISINGLY ACTIVE

The c1 are state of the art. Each woofer and Manger Sound Transducer is driven by one amplifier. Thanks to this division of tasks the chassis and amplifier can be perfectly matched. Intelligent filters for the low, mid and high frequency

range allow the c1 to adapt to specific requirements of room placement and acoustics. Lavish power reserves enable the c1 to master any challenge.

General

Type	Active 2-Way System
Frequency range	30 Hz – 40 kHz
Crossover frequency	330 Hz
Maximum SPL	110 dB
Dimensions (H x W x D)	19.5 x 10.6 x 16.7" (495 x 270 x 424 mm)
Weight	66.1 lbs (30 kg)

Amplifiers

Max. Power Output LF	250 W @ 8 Ohms Class AB
Max. Power Output HF	180 W @ 8 Ohms Class AB
Power Bandwidth HF	250 kHz (-3 dB)
Input Sensitivity	6 dBu (1.55 V) or 0 dBu
Input Impedance	10 kOhms
Input	XLR-3 (balanced)





COMPACT POWERHOUSE

z1

A great concert, your favorite artist unplugged – these are experiences that get under your skin. The unfiltered interaction between musician and audience stimulate your senses. The z1 trigger authentic, emotional, vivid and captivating moments in an understated design. Musical culture at its finest.



THOROUGH CONSTRUCTION

The uncompromisingly solid enclosure of the z1 is the ideal prerequisite for authentic sound reproduction. Rounded edges improve radiation, inner braces and the massive profile of the front panel reduce cabinet vibrations to a minimum.

The easily accessible loudspeaker connections are equipped with WBT nextgen™ binding posts – simply the best connectors available on the market.





HIGH-TECH AND CRAFTSMANSHIP

The z1 – like all Manger loudspeakers – combine traditional and modern values. Great craftsmanship ensures a manufacturing quality comparable to the finest luxury furniture. Innovative

technologies such as the Manger Sound Transducer are based on decades of experience as well as intensive research and development. The z1 fuse cutting-edge technology and top design.

General

Type	Passive 2-Way Compact Speaker
Impedance	4 Ohms
Frequency Range	40 Hz – 40 kHz
Crossover frequency	360 Hz
Sensitivity	89 dB 1 W/1 m
Maximum SPL	106 dB
Dimensions (H x W x D)	21.0 x 10.6 x 14.3" (534 x 270 x 364 mm)
Weight	57.3 lbs (26 kg)





WALL-MOUNTED WONDER



We live in modern times. Flat-screen TVs, tablet PCs and audio systems grow constantly and leave no room for big loudspeakers. The w1 are the perfect response to these new demands – they are compact and can be wall-mounted whilst retaining uncompromising technology and craftsmanship.

w1



VERSATILE SETUP

The easily wall-mountable and compact w1 complement stereo systems and modern flat-screen TVs. A single w1 can function as a center speaker in high-end surround systems. The w1 integrates

into any environment and excels in situations where mature and room-filling sound is desired and space is limited.





WELL CONNECTED

The w1 can be flush-mounted on a wall. The back panel of the loudspeaker provides recesses on the sides and bottom for easily connection of

large-diameter, high-quality cables. Solid binding posts ensure permanently clean signal transmission.

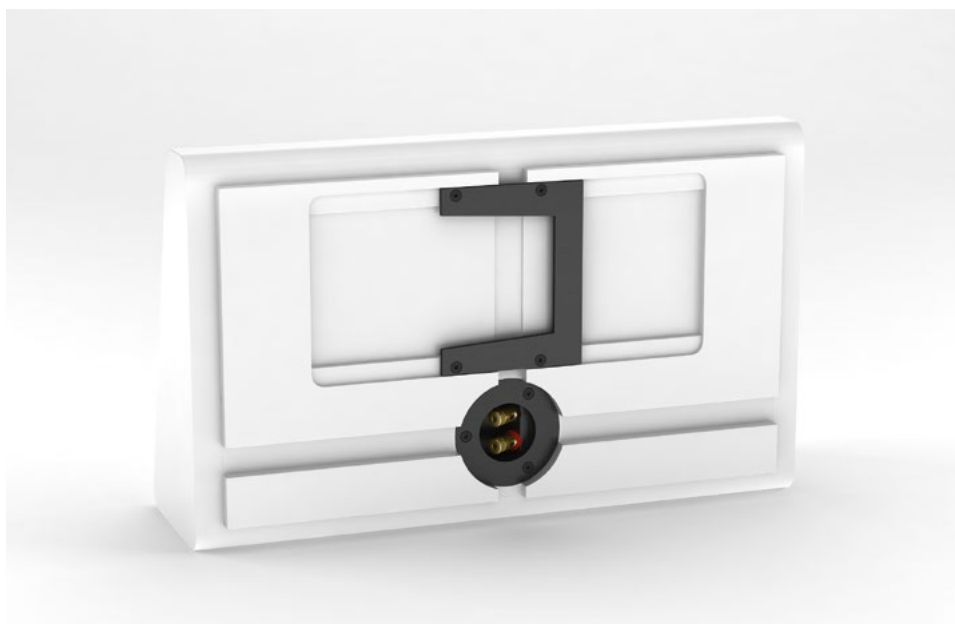

General

Type	Passive 1-Way On-Wall Speaker
Impedance	8 Ohms
Frequency range	150 Hz – 40 kHz
Crossover frequency	150 Hz
Sensitivity	89 dB 1 W/1 m
Maximum SPL	106 dB
Dimensions (H × W × D)	10.4 × 17.2 × 2.8/5.4" (264 × 436 × 71/136 mm)
Weight	17.6 lbs (8 kg)

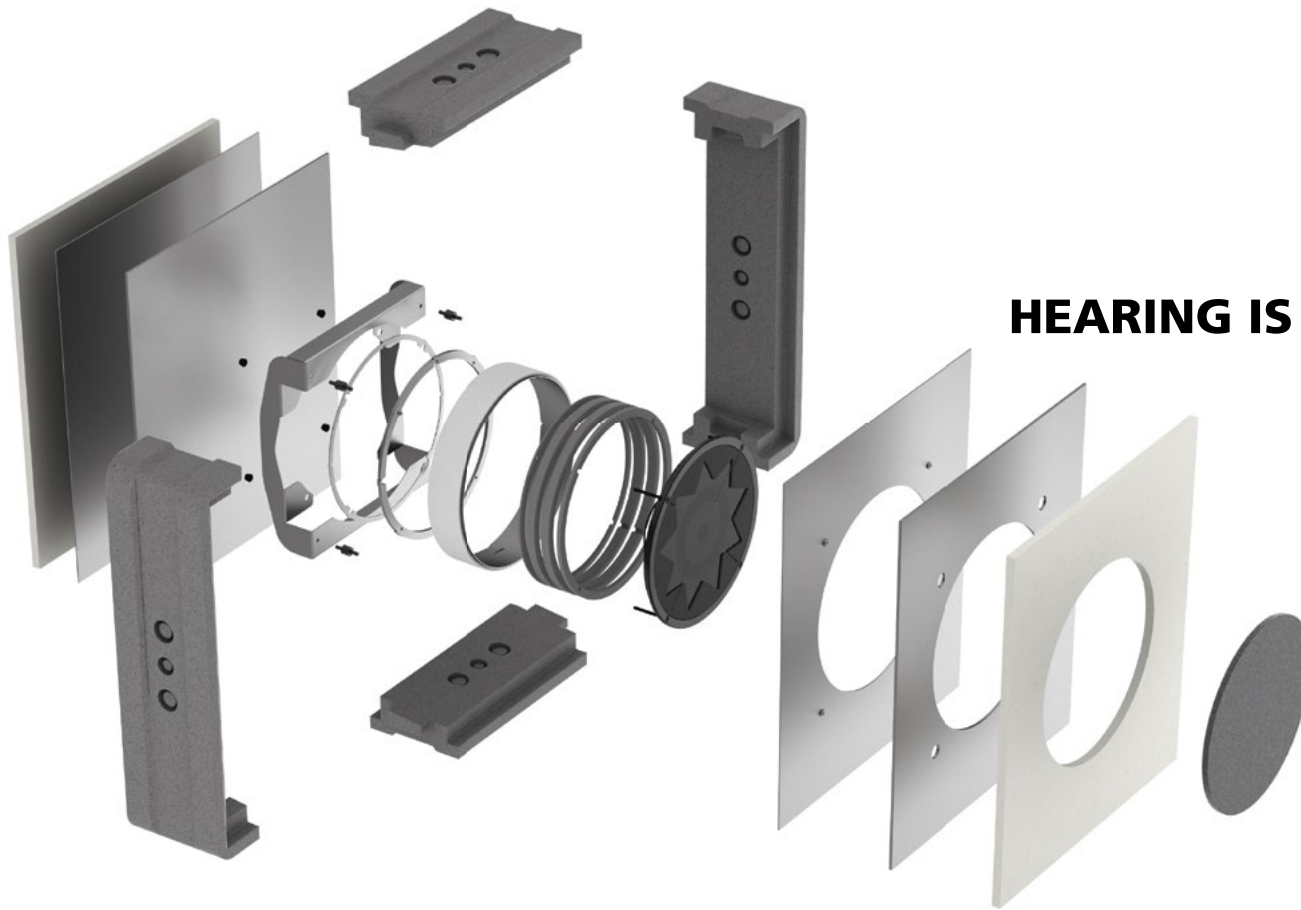

HEARING IS BELIEVING

i1

The almost invisible i1 offer the unique Manger Sound Transducer the ultimate environment for the best possible audio reproduction for in-wall installations thanks to high-end materials and thorough research. Besides their stellar

audiophile features, they also allow for a quick and easy workflow during the installation and come equipped with everything you need during the setup process.

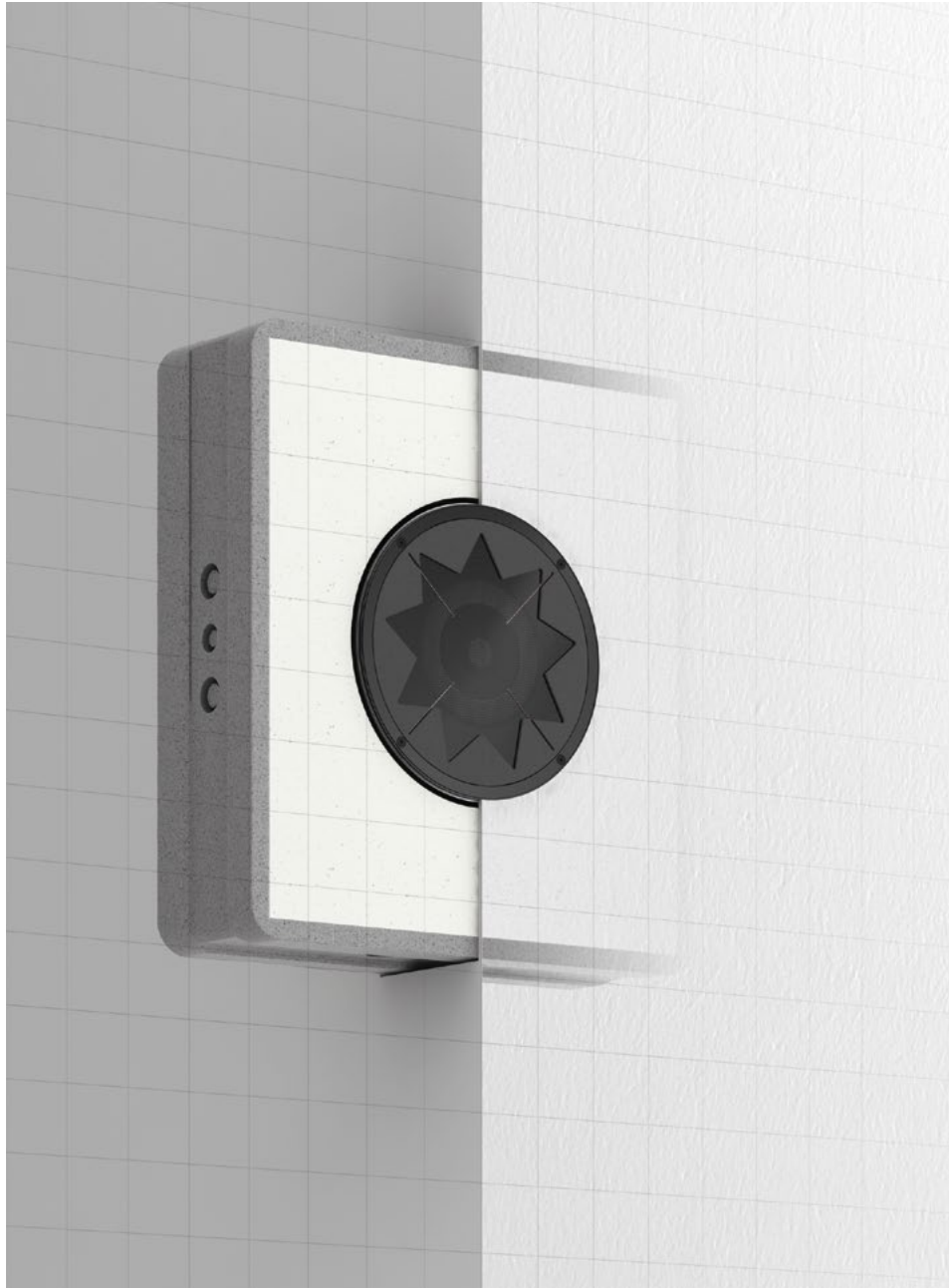

INTEGRATED INNOVATION

The i1 is the ultimate in-wall solution for your high end needs. It seamlessly blends into your wall and is perfect for both private and commercial spaces delivering the stellar sound quality Manger is widely known for.

General

Type	Passive 1-Way In-Wall Speaker
Impedance	8 Ohms
Frequency range	120 Hz – 40 kHz
Crossover frequency	120 Hz (optional without Crossover)
Sensitivity	89 dB (1 W/1 m)
Maximum SPL	106 dB
Product external dimensions	15.4 × 17.1 × 4.7" (390 × 435 × 120 mm)

Various

Recommended power handling	10 – 200 watts
Cabinet	EPS (high bulk density) and Gypsum fibre/metal sandwich construction (high sound reduction - SRI=59 dB)
Cut out dimensions	ø 8,7" (ø 221 mm)
Net weight	25.7 lbs (11,7 kg)
Mounting depth from surface	4,7" (120 mm)



Holoprofile

This soundguide was developed by Josef Manger. Perfectionists in particular will appreciate the qualities of the Holoprofile and notice how the contouring of the sound sources becomes even more accurate and the stability of the imaging out of the sweet spot.



Stand c1

These solid stands lift the c1 to their ideal height and highlight their beautiful design. The ingenious construction of the feet lets the loudspeakers fully unfold their sonic power. Standard height: 24" (612 mm).



Stand z1

These matching stands lift the z1 to their optimum height. The z1 rest on a solid top plate. The base plate can be equipped with spikes or decoupling systems. The glass bead blasted aluminum surface is available in natural or black finishes. Standard height: 20.5" (524 mm).



Reference-CD

“Music from another world” – The 15 tracks comprise not only different styles and recording techniques, but different artistic interpretations as well. We are particularly proud of the fact that we were overwhelmed with enthusiastic compliments directly after the first copies were released. These recordings, chosen with all our heart and soul, will mesmerize you.



Reference-LP

These vinyl records comprise the same tracks as the CD. They were meticulously cut into copper foil and pressed as a 180 gram double LP. In contrast to common practice the tracks were not adapted to vinyl in order to allow comparison of both media.

The track list is available on our website.

Colors and Finishes

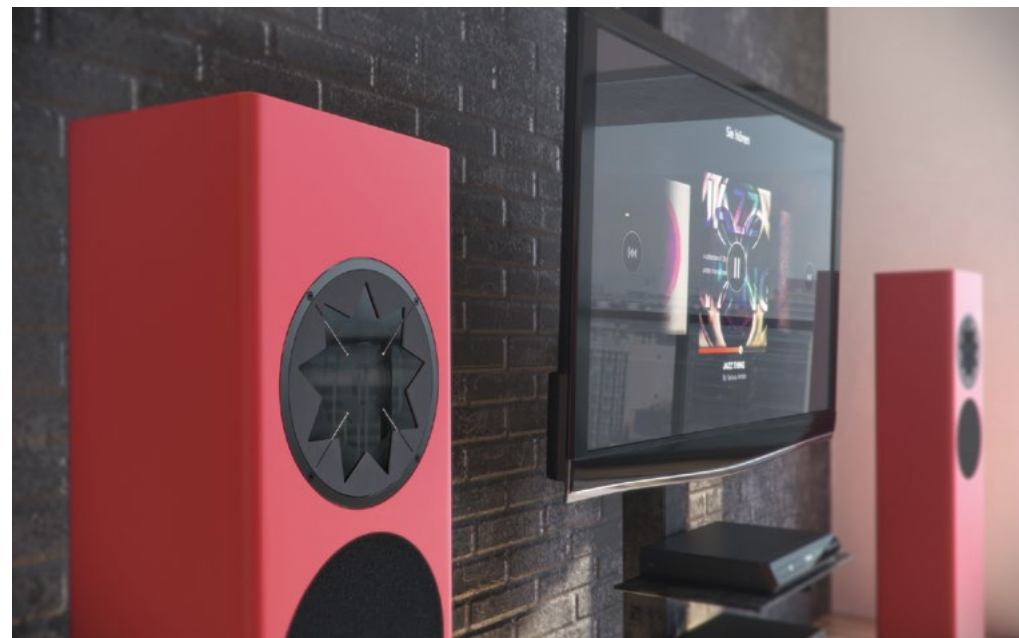



COLORS AND FINISHES

Manger considers loudspeakers as holistic entities and elements of daily life. Therefore, Manger not only offers a wide range of glossy or matt colors (all RAL and NCS colors) but also a broad selection

of premium veneers which permit perfect integration into your home. Unobtrusive pastel shades, black or white as well as sassy avant-garde colors in all imaginable variations.

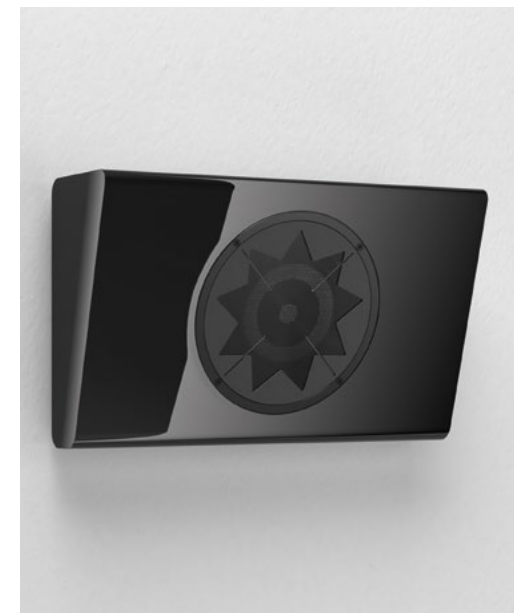

MANGER
PRECISION IN SOUND

MANGER AUDIO

Hendunger Strasse 53
97638 Mellrichstadt
Germany

Phone: +49 9776 9816

Web: www.mangeraudio.com

E-Mail: info@mangeraudio.com

VAT Ident.No.: DE132185274

Tax No.: 206/247/80125

WEEE-Reg.No.: DE 10375330

EORI No.: DE49 33 389

Manger-Schallwandler®, Manger-Schallsysteme®, Manger®,
High Definition Sound®, Holoprofil®, Manger-Wandler® are
registered trademarks of Manger Audio - Daniela Manger,
Hendunger Strasse 53, 97638 Mellrichstadt

Layout and Design: CMPLT, cmplt.com

Photo Credits:

Portrait Daniela Manger and photos of manufactory: Rainer Kurzeder,

Page 4 Great Titmouse: GlobalP (istock.com), Page 5 Josef Manger: Esteban Böhm,

Page 6 Drops of water: Jezperklauzen (istock.com)

your partner

 **Made in Germany**